

DO NOT SCALE FROM THIS PRINT

IPT1-1XX-XX-XX-D-RA-XXX

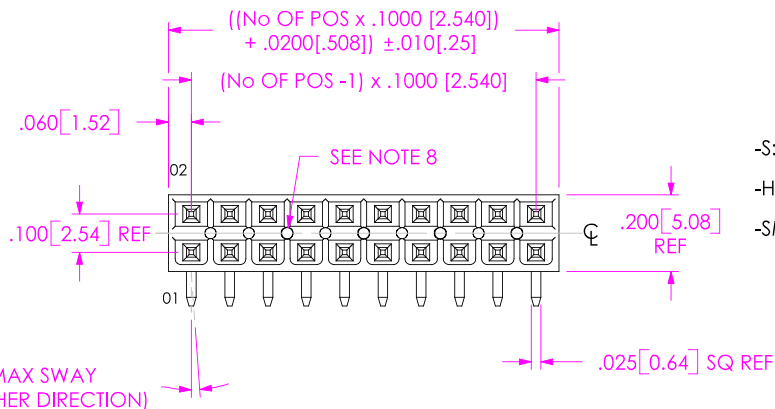

No OF POS PER ROW
-02 THRU -25

LEAD STYLE
-01

PLATING SPECIFICATION

-S: SELECTIVE GOLD (USE T-1S6-XX-S-2)
-H: HEAVY GOLD (USE T-1S6-XX-H-2)
-SM: SELECTIVE HEAVY GOLD, MATTE TIN TAIL (USE T-1S6-XX-SM-2)

OPTION

-POL: POSITION #1 REMOVED (USE IPT1-XX-D-P)
-FL: FRICTION LOCK [POS -05 THRU -25] (USE IPT1-XX-D-FL-X & T-1S64-XX-X) (FOR -FL-POL OPTION COMBINATION USE IPT1-XX-D-FL-P & T-1S64-XX-X)

TAIL OPTION

-RA: RIGHT ANGLE

ROW SPECIFICATION

-D: DOUBLE (USE IPT1-XX-D)

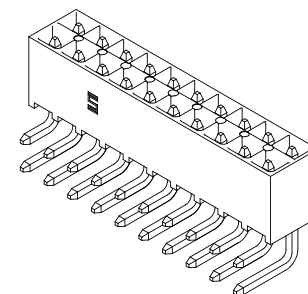
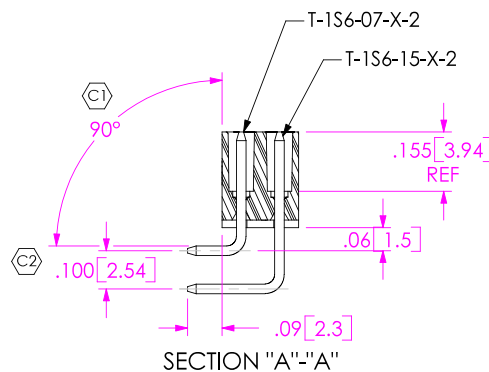
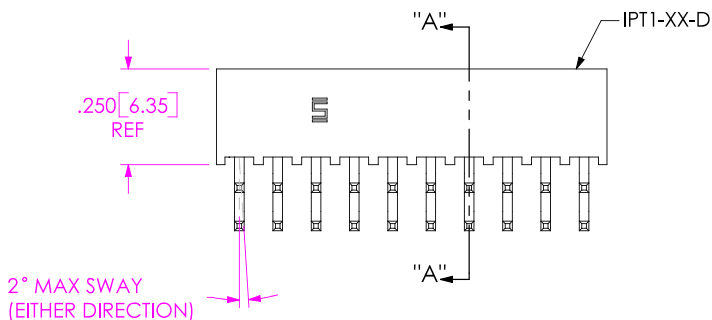

NOTES:

1. Ⓢ REPRESENTS A CRITICAL DIMENSION.
2. MAXIMUM ALLOWABLE CUT FLASH: $.010 [.25]$.
3. MINIMUM TERMINAL PUSH OUT FORCE: 2 lbs.
4. MAXIMUM VARIATION BETWEEN PIN ROWS: $.005 [.13]$.
5. "END WALLS" AFTER CUTTING SHOULD BE $.015 \pm .003 [.38 \pm .08]$.
6. NOTE DELETED.
7. ALL DIMENSIONS TO BE ABOUT CENTERLINE WITHIN $\pm .005 [.13]$.
8. PRESENCE OF VOIDS IS OPTIONAL AND PATTERN TO WHICH THEY OCCUR IS VARIABLE.
9. -T PLATING OPTION AVAILABLE FOR EXISTING CUSTOMERS ONLY.

PACKAGING VIEW

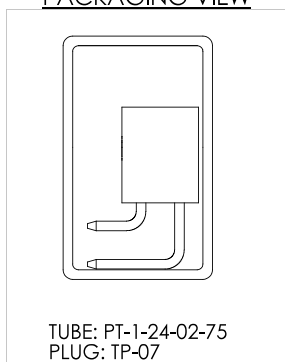

-FL: FRICTION LOCK OPTION

IPT1-110-01-X-D-RA-FL SHOWN

IPT1-XX-D-FL-X

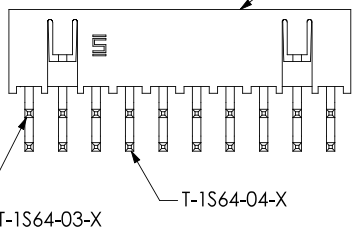

-POL: POLARIZED OPTION

IPT1-110-01-X-D-RA-POL SHOWN

IPT1-XX-D-P

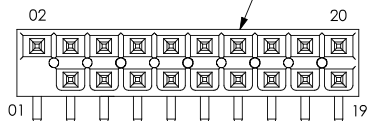

IN-PROCESS 1

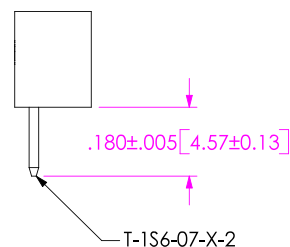

IN-PROCESS 2

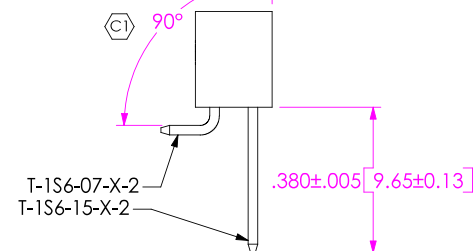

UNLESS OTHERWISE SPECIFIED, DIMENSIONS ARE IN INCHES. TOLERANCES ARE:
DECIMALS: .XX: $\pm .01 [.3]$
.XXX: $\pm .005 [.13]$
.XXXX: $\pm .0020 [.051]$

PROPRIETARY NOTE

THIS DOCUMENT CONTAINS INFORMATION CONFIDENTIAL AND PROPRIETARY TO SAMTEC, INC. AND SHALL NOT BE REPRODUCED OR TRANSFERRED TO OTHER DOCUMENTS OR DISCLOSED TO OTHERS OR USED FOR ANY PURPOSE OTHER THAN THAT WHICH IT WAS OBTAINED WITHOUT THE EXPRESSED WRITTEN CONSENT OF SAMTEC, INC.

MATERIAL: DO NOT SCALE DRAWING
INSULATOR: VECTRA E130i, COLOR: BLACK
CONTACT: PHOS BRONZE, 510, 3/4 HARD

SHEET SCALE: 2:1

SAMTEC

520 PARK EAST BLVD, NEW ALBANY, IN 47150
PHONE: 812.944.6733 FAX: 812.948.5047
e-Mail: INFO@SAMTEC.COM CODE: 55322

DESCRIPTION: .100 DOUBLE ROW SHROUDED TERMINAL ASSEMBLY

DWG. NO. IPT1-1XX-XX-XX-D-RA-XXX

BY: DEAN P 11-05-2002 SHEET 1 OF 1